

1509876HC1401



LOSSNAY HEAT RECOVERY VENTILATOR (RESIDENTIAL USE)

MODEL:

VL-220CZGV-E

Instruction Manual

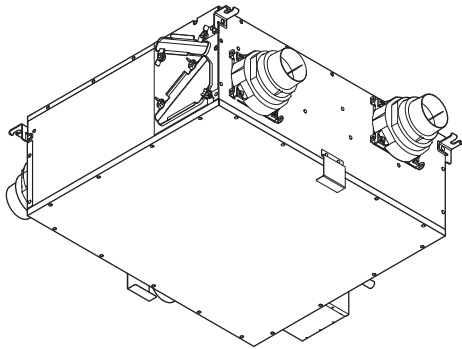
LOSSNAY HEAT RECOVERY VENTILATOR (RESIDENTIAL USE)
MODEL
VL-220CZGV-E
Instruction Manual
For user

Contents







1. Safety Precautions	1 - 2
2. Features	2
3. Preparations Before Use	3
4. Names and Functions of Parts	3
5. How to Use	4 - 12
6. Maintenance	13 - 14
7. Troubleshooting	15
8. Specifications	16
9. After-Sales Service	16

Do not attempt to install the product by yourself. (Safety and proper functions of the product may not be assured.)





- This product is for residential use.
- To ensure correct and safe use, read the instruction manual thoroughly. Before using the product, check "Safety Precautions" to use it correctly and safely.
- After reading, store the manual in a handy location for easy access.

1. Safety Precautions

The following symbols denote the type and degree of danger resulting from incorrect handling.

 WARNING		Incorrect handling of the product may result in serious injury or death.	
 Prohibited	<p>Do not turn on or off the remote controller when corrosive gas has leaked. Sparks from electric contacts may cause the gas to explode.</p> <p>Do not use the product in hot places, in the direct sunlight and in smoky places. Failure to heed this warning may result in fire.</p>	 Follow instructions	<p>Use 220 to 240 V AC power. Failure to heed this warning may result in fire, electric shock or damage to the circuit boards.</p> <p>Make sure that the outside air intake vent is located at a position where combustion gas or other similar exhaust is not sucked in. Inability to bring in fresh air may result in lack of oxygen in the room.</p> <p>Be sure to turn off the remote controller and the circuit breaker on the power board before cleaning and maintenance. Failure to heed this warning may result in electric shock or injury.</p> <p>If an abnormality occurs (for example, when you smell burning), stop operation, and turn off the circuit breaker on the power board. If operation of the product is continued in this state, this may result in malfunction, electric shock or fire.</p>
 No water exposure	<p>Refrain from immersing in water or splashing the product with water. Failure to heed this warning may result in fire or electric shock.</p>		<p>If an abnormality or malfunction occurs, immediately stop use of the product. Continued use of the product in this state may result in smoking, ignition fire, electric shock, or injury.</p>
 No disassembly	<p>Do not modify or disassemble the product using tools. Failure to heed this warning may result in fire, electric shock or injury.</p>		<p>Contact an electrical contractor to work electrical wiring. Incorrectly electrical work may result in electric shock.</p>
 Cannot be installed in a bathroom	<p>Make sure that the product is not installed at a bathroom or other humid location. Failure to heed this warning may result in electric shock or injury.</p> <p>Make sure that the remote controller is not installed in a bathroom. Failure to heed this warning may result in electric shock.</p>		<p>Make sure that the product is installed at a horizontal. Water leakage may result in damage to property or household effects, and injury may result if the product should fall.</p> <p>Make sure that an outdoor hood, that makes it less likely for rain water, snow or small animals (e.g. bats) from entering, is installed at the ends of supply air and exhaust ducts. Failure to heed this warning may cause rain penetration, resulting in electric shock/fire or water damage to household property.</p>
 Check grounding	<p>Make sure that the product is grounded. Device failure and electric leakage may cause electric shock.</p> <p>About installing a ground, contact your dealer or an electrical contractor.</p>		<p>If the product will not be operated for a long period of time, be sure to turn off the circuit breaker on the power board. Failure to heed this warning may result in electric shock due to deteriorated insulation or fire due to electric leakage.</p>

1. Safety Precautions (continued)

 <h2 style="margin: 0;">CAUTION</h2>		<p>Incorrect handling of the product may result in injury or damage to property or household effects.</p>	
 Prohibited	<p>Do not use the Lossnay unit at locations where toxic gas or gas containing corrosive components such as acids, alkaline, organic solvents, or paints is generated. Failure to heed this warning may result in malfunction.</p> <p>Do not place objects under the product. Dew condensation water may drip.</p> <p>During cleaning and maintenance, do not climb on an unstable stand. Injury may result if you tumble down.</p>	 Follow instructions	<p>Do not spray the Lossnay unit, wall switch, or supply air/exhaust grille with an insecticide, hair, or cleaning spray. Failure to heed this warning may deform or damage parts.</p> <p>This appliance is not intended for use by persons (including children) with reduced physical sensory or mental capabilities, or lack of experience and knowledge, unless they have been given supervision or instruction concerning use of the appliance by a person responsible for their safety. Children should be supervised to ensure that they do not play with the appliance. (This appliance can be used by children aged from 8 years and above and persons with reduced physical, sensory or mental capabilities or lack of experience and knowledge if they have been given supervision or instruction concerning use of the appliance in a safe way and understand the hazards involved. Children shall not play with the appliance. Cleaning and user maintenance shall not be made by children without supervision.)</p>
 Follow instructions	<p>Make sure that drain piping is installed at the discharge outlet.</p> <p>Wear gloves during cleaning and maintenance. Failure to heed this warning may result in injury.</p> <p>When removing the supply air filter case and exhaust filter case, dew condensation water that has built up inside sometimes drips. So, remove the filter cases gently by supporting them with both hands so that they are not tilted.</p> <p>Securely install the parts after cleaning and maintenance. Injury may result if the parts should fall.</p>		

Requests on Use

- When this product ventilates, it takes in cold air from the outside in winter. For this reason, when the outside air temperature drops, moisture in the air around the product condensates, and water drops sometimes adhere to the product or drop. This, however, is not a malfunction. Wipe off any water droplets.
- When outside air temperatures are low and operation of the product is stopped, operation of the ventilator or pressure of the outside wind might cause outside air to flow in from the product, which may result in dew condensation forming on the product and other parts. This is not a malfunction. Wipe off any water droplets.
- When a lot of humidity is generated from building materials at newly built houses, dew condensation may form on the product and other parts. This is not a malfunction. Wipe off any water droplets.
- When a strongly fragrant scent, etc. is used in toilets, bath rooms and wash basins, or when cigarette or other smoke is discharged, odor is sometimes sense from the air vent.
- Operating noise may be a cause of concern directly underneath the product.
- When ventilating a bathroom, operate the product for 24 hours.

2. Features

What is the LOSSNAY HEAT RECOVERY VENTILATOR...?

- ◆ Effective ventilation routes can be achieved in the entire house by the supply air vent and the exhaust vent being installed at locations away from each other depending on the duct connection method.
- ◆ Built-in filters reduce the influx of dust, pollen, etc. in outside air before the air is supplied to rooms.

During heat exchanger operation

Dirty air from inside the room is discharged (=exhaust), and clean air from the outside is taken into the room (=air supply). During this time, air is discharged and taken in through the Lossnay core (heat exchanger). As a result, air is ventilated while reusing (heat collection) the warmth or coolness of the room which is discarded during ventilation.

- ◆ When air conditioning is used in summer and winter, heat exchange ventilation reduces the load placed on air conditioning to ensure energy savings.

During “By-pass” operation

When exhaust and air supply are performed, air is supplied to the room without any change in the outside air temperature due to exhaust being performed without passing through the Lossnay core.

* This function can be used only when the optional motorized damper (P-133DUE-E) is used.

- ◆ In spring and fall, and summer nights, for example, the cool air of the outside is taken in.

3. Preparations Before Use

- **Receive an explanation about operation procedures and the correct method of use to ensure safe operation.**
Make sure that trial operation and operation checks described in the Installation Manual have been carried out.
- **Do not stop operation except in the following instances. (Resume operation after the Lossnay unit has been temporarily stopped.)**
 - When there is heavy snow, strong winds or heavy rain such as snowstorms or typhoons
 - When there is thick fog
 - During cleaning and maintenance
- **When a lot of humidity is generated from building materials at newly built houses, dew condensation may form on the product and other parts. So, switch the operation mode to temporarily stop operation, and open the windows.**
- **Use the following procedure to check the positions and operation methods.**
Inspection opening ... It is required for maintenance on the product. This product is installed in house attics.
So, maintenance is performed in the attic.
 - If there is no inspection opening for maintenance or you find the inspection opening and product position are out of their designated dimensions after checking the layout drawing for the inspection opening given in the Installation Manual, contact your dealer or electrical contractor.

Grills.....They are required on the supply air and exhaust sides of the Lossnay unit. To reduce the frequency of cleaning the filters on the Lossnay unit, we recommend using a filter for taking up dust in the room in the exhaust grill.



Remote controller...It is required for starting and stopping operation of the Lossnay unit and for switching the fan speed.

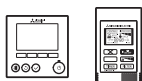

Note:

- The Lossnay unit is not an air-conditioner.
- We recommend local ventilation for discharge cigarette smoke, etc.
- We recommend installing beds away from the supply air vent. (During sleep, you may be bothered by the operating sound of the Lossnay unit or feel cold air.)

4. Names and Functions of Parts

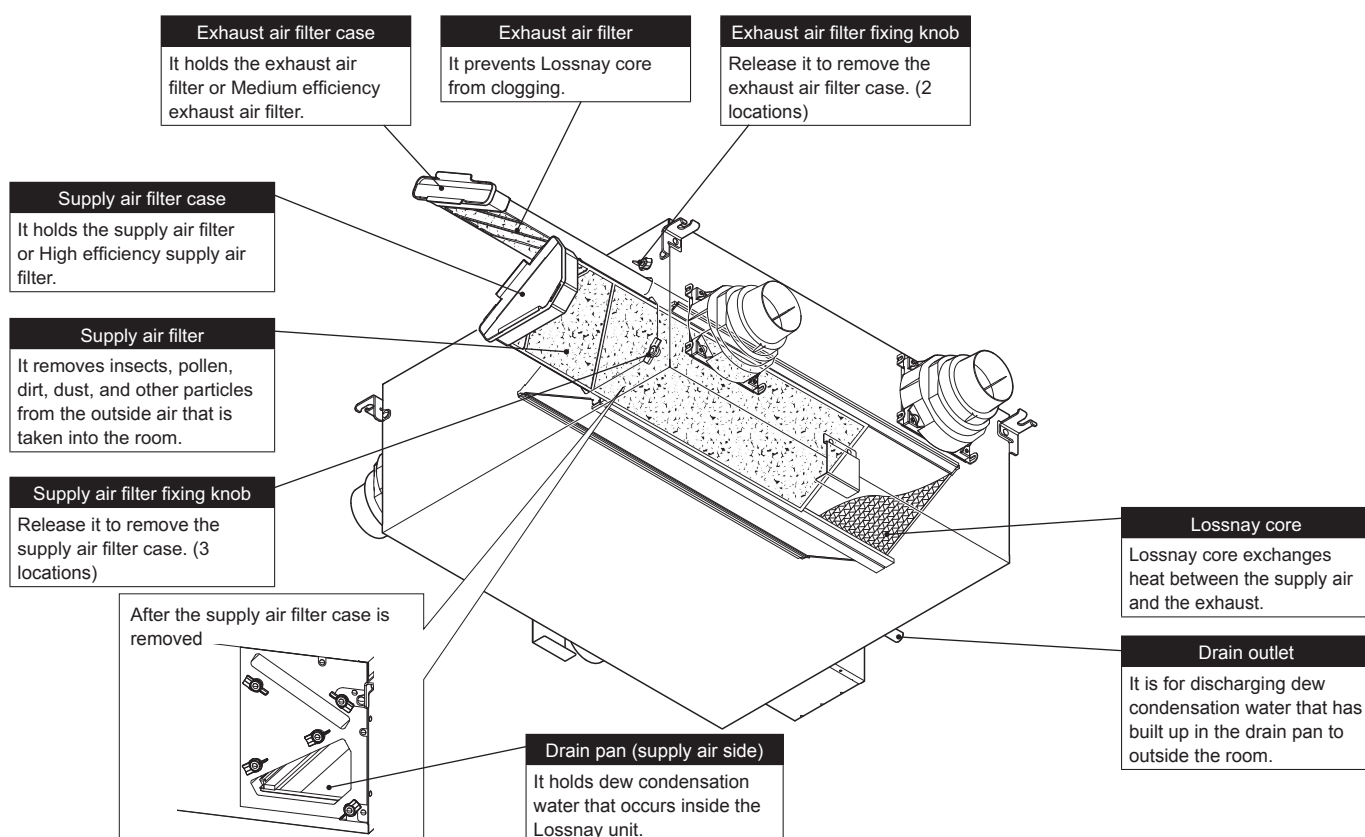

5. How to Use

When using PZ-61DR-E

Also read the Instruction Book for the remote controller (PZ-61DR-E).
This cannot be used together with the remote controller (PZ-43SMF-E).

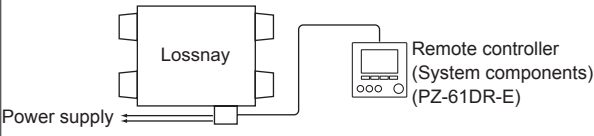
System example	Operation
 <p>Power supply → Lossnay → Remote controller (System components) (PZ-61DR-E)</p>	Operate the product by the remote controller.

Names and functions of controller components

Controller interface

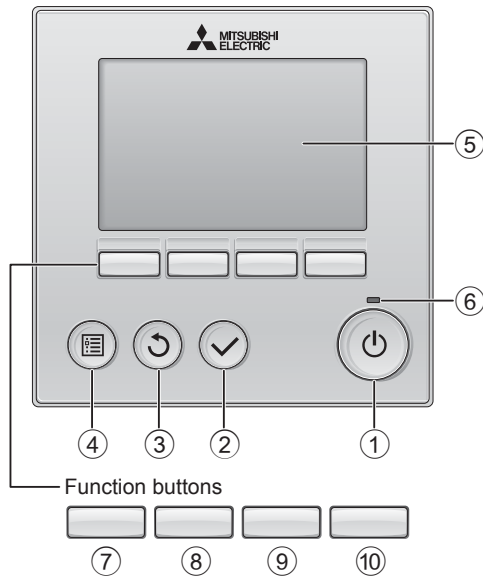

① ON/OFF button

Press to turn ON/OFF the Lossnay unit.

② SELECT button

Press to save the setting.

③ RETURN button

Press to return to the previous screen.

④ MENU button

Press to bring up the Main menu.

⑤ Backlit LCD

Operation settings will appear.
When the backlight is off, pressing any button turns the backlight on and it will stay lit for a certain period of time depending on the screen.

When the backlight is off, pressing any button turns the backlight on and does not perform its function. (except for the ON/OFF button)

⑥ ON/OFF lamp

This lamp lights up in green while the unit is in operation. It blinks while the remote controller is starting up or when there is an error.

The functions of the function buttons change depending on the screen. Refer to the button function guide that appears at the bottom of the LCD for the functions they serve on a given screen. When the system is centrally controlled, the button function guide that corresponds to the locked button will not appear.

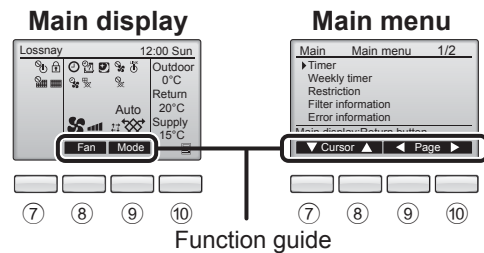

⑦ Function button F1

Main menu: Press to move the cursor down.

⑧ Function button F2

Main display: Press to change the fan speed.
Main menu: Press to move the cursor up.

⑨ Function button F3

Main display: Press to change the ventilation mode*.
Main menu: Press to go to the previous page.

⑩ Function button F4

Main menu: Press to go to the next page.

If LOSSNAY does not have the function or operation is not possible, the operation guide is not displayed.

* The mode can be switched only when the optional motorized damper (P-133DUE-E) is used.

5. How to Use (continued)

Display

* All icons are displayed for explanation.

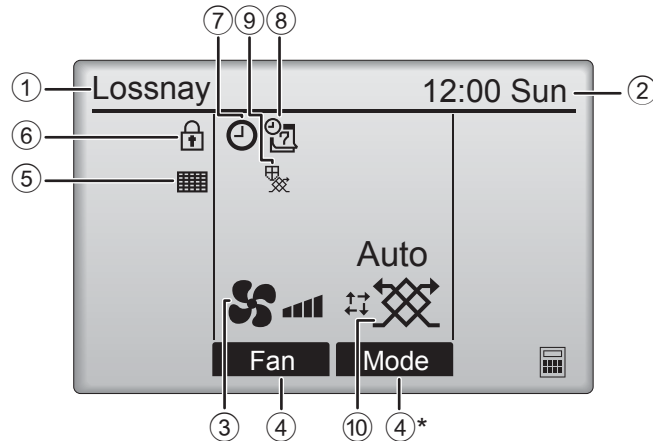

① Remote controller name

Lossnay is always displayed.

② Clock (See the Installation Manual.)

Current time appears here.

③ Fan speed

Fan speed setting appears here.

④ Button function guide

Functions of the corresponding buttons appear here.

* The mode appears only when the optional motorized damper (P-133DUE-E) is used.

⑤

Indicates when filter needs maintenance.

⑥

Appears when the buttons are locked and/or a fan speed is skipped.

⑦

Appears when the On/Off timer, or Auto-off timer function is enabled.

⑧

Appears when the Weekly timer is enabled.

⑨

Appears when performing operation to protect the equipment.

⑩ Ventilation mode

Indicates the ventilation mode setting.

* The mode appears only when the optional motorized damper (P-133DUE-E) is used.

5. How to Use (continued)

Basic operations

Power ON/OFF

ON

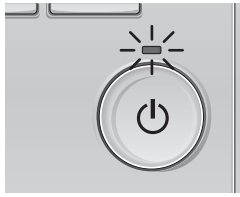

Press the **ON/OFF** button.
The ON/OFF lamp will light up in green, and the operation will start.

OFF



Press the **ON/OFF** button again.
The ON/OFF lamp will go out, and the operation will stop.

Fan speed

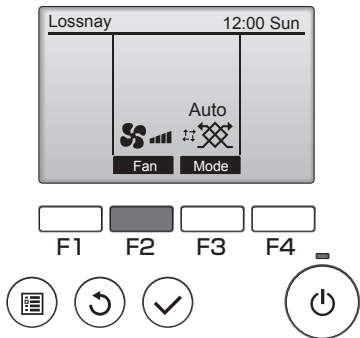

Press the **F2** button to go through the fan speeds in the following order.



A fan speed that is skipped because of a fan skip setting is not displayed.

Ventilation mode

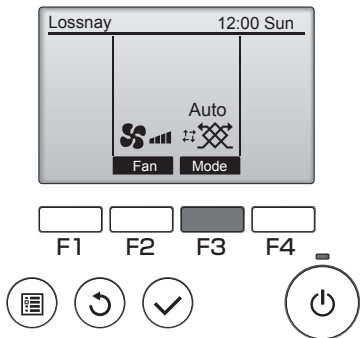

Press the **F3** button to go through the Ventilation mode in the following order.



* The mode can be switched only when the optional motorized damper (P-133DUE-E) is used.

Display	Function
Auto / Auto ↔↔↔ / ↔↔↔	The mode is switched automatically between the heat exchanger mode and by-pass mode. Initial preset temperature: At 22 °C to 28 °C, the by-pass mode is used. Details on how to change the temperature setting are given in the Lossnay unit (VL-220CZGV-E) Installation Manual, "Function Setting."
↔↔↔	The Lossnay unit runs in the heat exchanger mode.
↔↔↔	The Lossnay unit runs in the by-pass mode.

When the outdoor air temperature decreases to 8 °C or lower, the mode is switched automatically to heat exchanger mode even if Ventilation mode was set. The indication on the remote controller remains as by-pass mode. (Freeze prevention)

5. How to Use (continued)

■ Controller operation-Function settings

Clock

Button operation

1

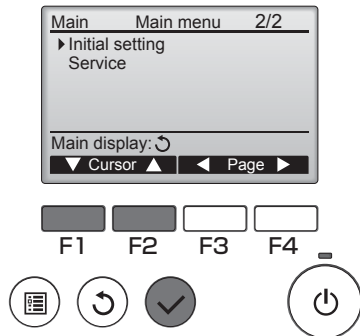

Select "Initial setting" from the Main menu, and press the **SELECT** button.

Enter maintenance password "0000" is displayed. Enter the initial password "9999" and press the **SELECT** button.

* For details on how to change the password, refer to the PZ-61DR-E Instruction Manual.

Clock setting is required before making the following settings.

- On/Off timer
- Weekly timer

2

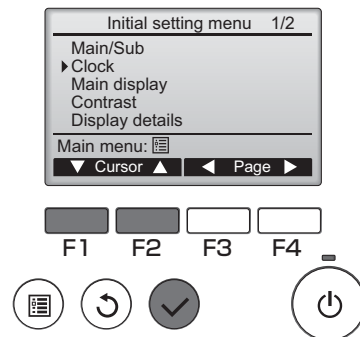

Move the cursor to the "Clock" with the **F1** or **F2** button, and press the **SELECT** button.

3

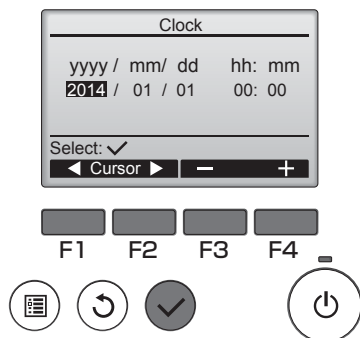

Move the cursor to the desired item with the **F1** or **F2** button out of year, month, date, hour, or minute.

Increase or decrease the value for the selected item with the **F3** or **F4** button, and press the **SELECT** button.

A confirmation screen will appear.

Navigating through the screens

- To go back to the Main menu **MENU** button
- To return to the previous screen **RETURN** button

5. How to Use (continued)

Language selection

Function description

The desired language can be set. The language options are English, French, German, Spanish, Italian, Portuguese, Swedish, and Russian.

Button operation

1

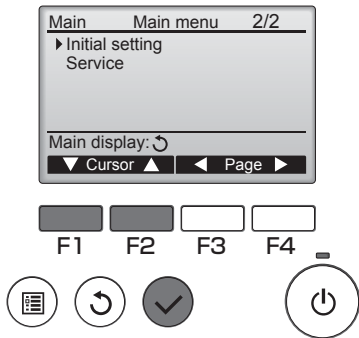

Select "Initial setting" from the Main menu, and press the **SELECT** button.

Enter maintenance password "0000" is displayed. Enter the initial password "9999" and press the **SELECT** button.

* For details on how to change the password, refer to the PZ-61DR-E Instruction Manual.

2

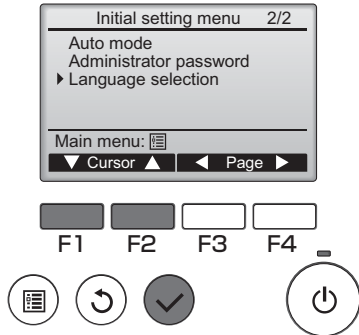

Move the cursor to the "Language selection" with the **F1** or **F2** button, and press the **SELECT** button.

3

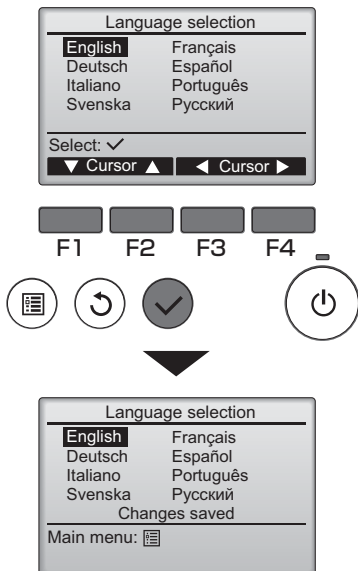

Move the cursor to the language you desire with the **F1** through **F4** buttons, and press the **SELECT** button to save the setting.

When the power is on for the first time, the Language selection screen will be displayed. Select a desired language. The system will not start-up without language selection.

A screen will appear that indicates the setting has been saved.

Navigating through the screens

- To go back to the Main menu **MENU** button
- To return to the previous screen **RETURN** button

5. How to Use (continued)

■Maintenance

Filter information

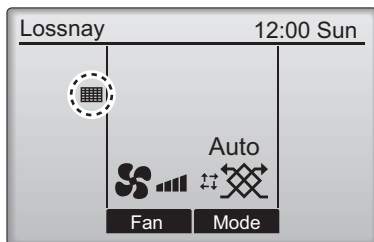

 will appear on the Main display when it is time to clean the filter.

Clean, or replace the filter when this sign appears. For details on how to clean, see pages 13 and 14.

* To use the function, change the Initial setting according to the Installation Manual for VL-220CZGV-E.

Button operation

1

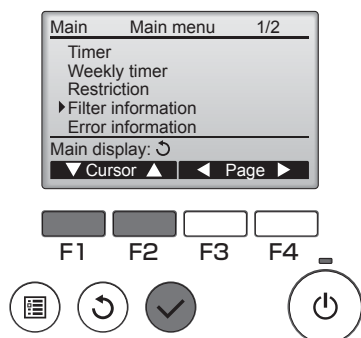

Select "Filter information" from the Main menu , and press the **[SELECT]** button.

2

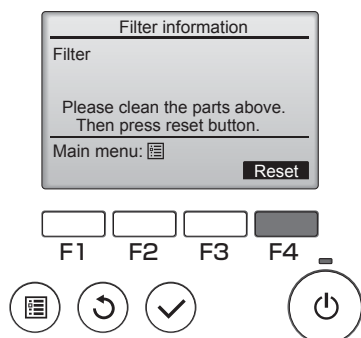

Press the **[F4]** button to reset cleaning sign.

3



Select "OK" with the **[F4]** button.

4

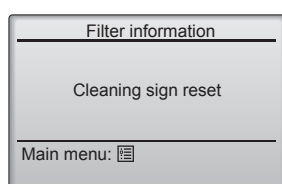

A confirmation screen will appear.

5. How to Use (continued)

■ Maintenance

Care of the remote controller

To remove dirt from the remote controller's display window, wipe with a cloth to which detergent has been applied; and then wipe with a dry cloth to remove any remaining detergent.

Do not use the following solvents. (They will change the quality and the color.)

- Paint thinner, alcohol, benzene, gasoline, kerosene, spray cleaner, cleaning alkali, etc.

■ Timer, Weekly timer

The settings for Timer and Weekly timer operation can be made from the remote controller.

Press the **MENU** button to go to the Main menu, and move the cursor to the desired setting with button **F1** or **F2**. Refer to the Instruction Book of the remote controller for further information.

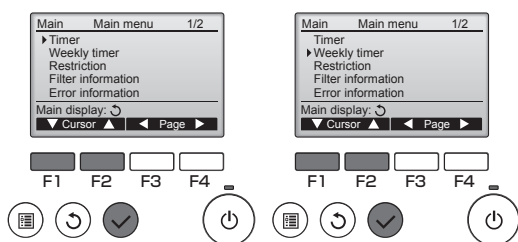

Timer

- On/Off timer
Operation On/Off times can be set in 5-minute increments.
- Auto-Off timer
Auto-Off time can be set to a value from 30 to 240 in 10-minute increments.

Weekly timer

- Operation On/Off times for a week can be set.
Up to eight operation patterns can be set for each day.

■ Troubleshooting

Error information

When an error occurs, the following screen will appear.
Check the error status, stop the operation, and consult your dealer.

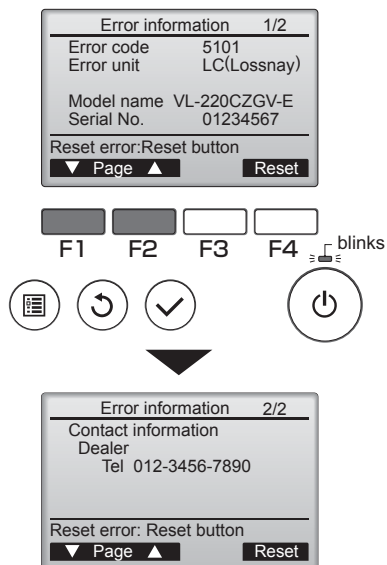

Error code, error unit, unit model name, and serial number will appear.

The model name and serial number will appear only if the information have been registered.

Press the **F1** or **F2** button to go to the next page.

Contact information (dealer's phone number) will appear if the information have been registered.

■ After-Sales Service

After-sales servicing of the remote controller unit should be ordered from the dealer from where this product was purchased.

5. How to Use (continued)

When using PZ-43SMF-E

Also read the Instruction Book for the remote controller (PZ-43SMF-E).

This cannot be used together with the remote controller (PZ-61DR-E).

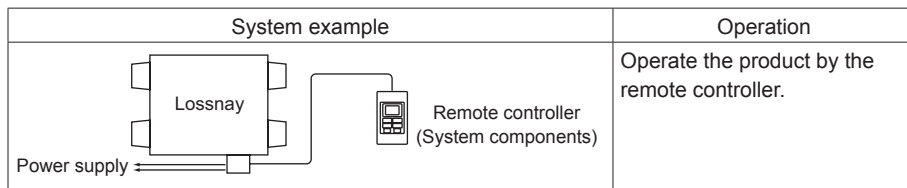

■ Component Names

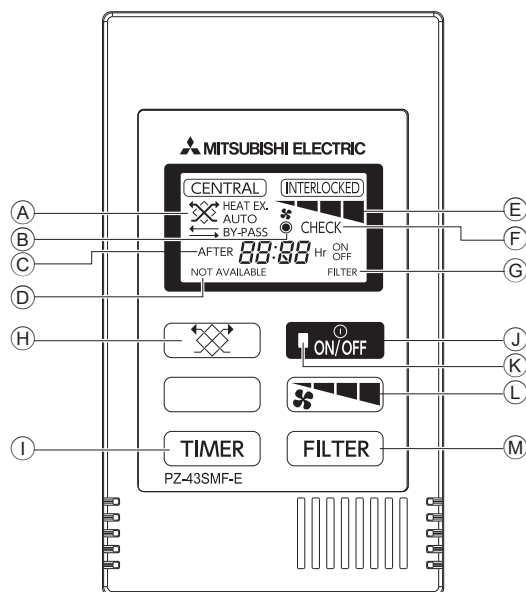

(A) Ventilation mode

Displayed the ventilation mode status.

Heat exchange



HEAT EX.

By-pass



BY-PASS

Automatic (HEAT EX./BY-PASS)



HEAT EX. AUTO

or



AUTO BY-PASS

* The mode appears only when the optional motorized damper (P-133DUE-E) is used.

(B) Power Display

Displayed while the Lossnay remote controller is powered on.

(C) [TIMER] Display

Displayed on-timer or off-timer duration.

(D) [NOT AVAILABLE] Display

When a button is pressed for a function which the Lossnay unit cannot perform, this display flashes concurrently with the display of the function.

(E) Fan speed Display

Displayed the selected fan speed.

(F) [CHECK] Display

Displayed together with the malfunctioning unit (3 digits) and an error code (4 digits).

(G) [FILTER] Display

Displayed when the accumulated operating time reaches at the time set for filter maintenance.

(H) [Ventilation mode] Button

Used to select the ventilation mode among heat exchange, by-pass or automatic.

* The mode can be switched only when the optional motorized damper (P-133DUE-E) is used.

(I) [TIMER] Button

Increasing 0:30 by pressing it once.

Keep pressing the button for fast-forwarding.

(J) [ON/OFF] Button

Switch for start and stop.

(K) Operation lamp

On during operation. Flashes when a malfunction occurs.

(L) [Fan Speed] Button

Used to select the fan speed either "Low" or "High".

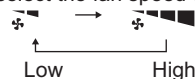

Note: If this button is pressed when trying to switch the fan speed of a Lossnay unit which is not equipped with the fan speed adjustment, the fan speed display and NOT AVAILABLE display flash and the unit's fan speed does not change.

(M) [FILTER] Button

Press twice to reset the filter sign display.







Note:

- When power is restored after an outage or when the corresponding circuit breaker on the power board is reset, all models will return to the condition before the supply of power was interrupted.
- When the backlight is off, pressing any button turns the backlight on and does not perform its function. (except "ON/OFF" button)

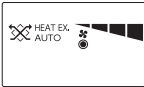

5. How to Use (continued)

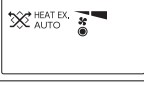
■ Mode of Use

Independent operation of the Lossnay unit:

Operation	Relevant button	Relevant display items	Sequence
Starting the Lossnay unit			Press the "ON/OFF" button and check that the operation lamp turns on.
Setting the Ventilation mode * The mode can be switched only when the optional motorized damper (P-133DUE-E) is used.			Press the "Ventilation mode" button: Each time it is pressed, the corresponding display will change in accordance with the sequence [HEAT EX.] (non-automatic) --> [BY-PASS] (non-automatic) --> [AUTO]. If [AUTO] is selected, the display will change to indicate the current mode after three seconds have passed.
Selecting the fan speed			Press the "Fan Speed" button to select either Low or High fan speed.
Stopping the Lossnay unit	 Operation lamp		Press the "ON/OFF" button. (and check the operation lamp turns off.)

■ Maintenance

	Relevant button	Relevant display items	Sequence
Filter reset (Clear of the total operation time)	 Double pressing		Press the "FILTER" button twice quickly, then "FILTER" indication will be disappeared.
Cleaning of the Lossnay unit's filter	For details on how to clean, see pages 13 and 14.		
Care of the remote controller	To remove dirt from the remote controller's display window, wipe with a cloth to which detergent has been applied, and then wipe with a dry cloth to remove any remaining detergent. Do not use the following solvents. (They will change the quality and the color.) - Paint thinner, alcohol, benzene, gasoline, kerosene, spray cleaner, cleaning alkali, etc.		

■ After-Sales Service

- If any of the following inspection numbers should be displayed on the remote controller, please contact your dealer from where the product was purchased for more information.
4000, 5101, 5102, 3602, 3600, 0900
- After-sales servicing of the remote controller unit should be ordered from your dealer from where the product was purchased.

6. Maintenance

To keep the Lossnay functions in good condition for a long time, clean dirt or dust from the filters periodically (at least once every six months or more frequently depending on the operating environment). Clean dirt or dust in the Drain pan (supply air side) periodically (at least once every six months or more frequently depending on the operating environment).

⚠ WARNING

Be sure to turn off the remote controller and the circuit breaker on the power board before cleaning and maintenance.

Failure to heed this warning may result in electric shock or injury.

⚠ CAUTION

Wear gloves during cleaning and maintenance.

Failure to wear gloves may result in injury.

During cleaning and maintenance, do not climb on an unstable stand.

Injury may result if you tumble down.

Securely install parts after cleaning and maintenance.

Injury could result if parts fall.

How to remove parts

Removing the filter

- (1) Set the ON/OFF button on the remote controller to "OFF".
- (2) Turn the three supply air filter fixing knobs to unlock the knobs.

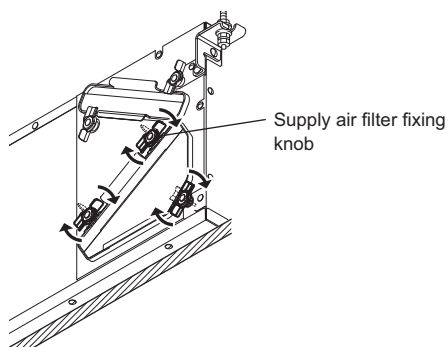

- (3) Gently draw out the supply air filter case.

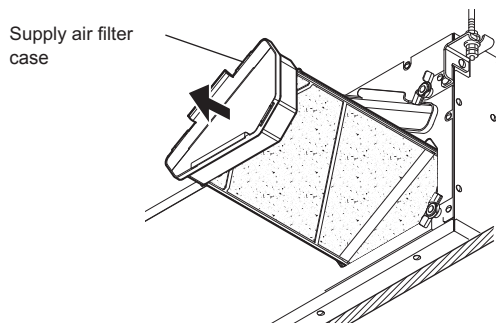

- (4) Turn the two exhaust air filter fixing knobs to unlock the knobs.

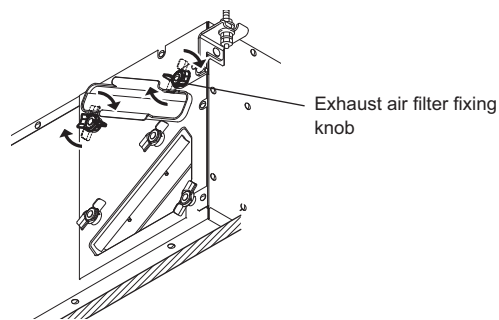

- (5) Gently draw out the exhaust air filter case.

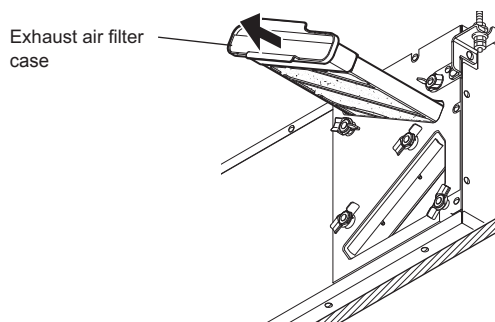

Note:

- Dirt or dust may fall when the air filter cases are removed. Also, dew condensation water sometimes builds up in some operating environments. Remove the air filter cases gently by supporting them with both hands so that they are not tilted while taking care not to spill or be splashed with dew condensation water.

Remove the air filters from the supply air filter case and the exhaust air filter case

Supply air filter : 2 sheets

Exhaust air filter : 2 sheets

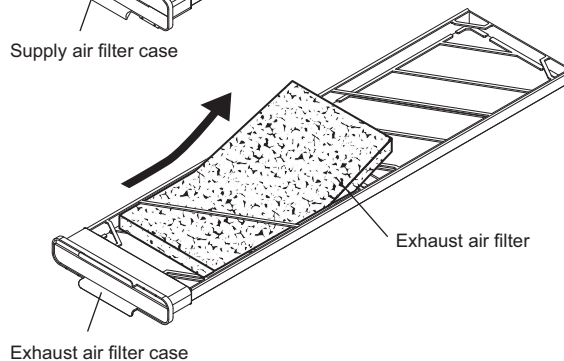
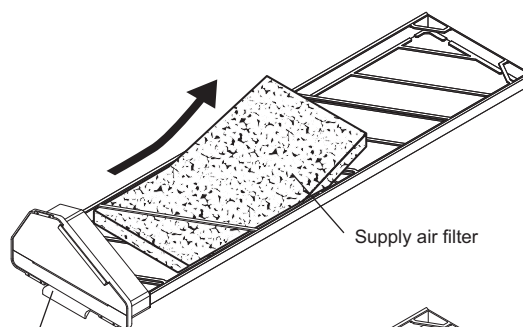

6. Maintenance (continued)

How to clean the supply air filters and exhaust air filters

Clean at least once every 6 months.

Either lightly tap with your hand or wipe off dust with a vacuum cleaner.

If the filter is heavily soiled, press and wash the filter with cold or warm water (40°C or less), and then let them dry sufficiently.

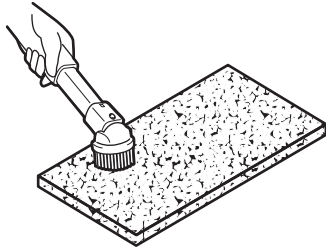

Note:

- When a filter is damaged or it has been washed with water about four times, replace with the Standard Replacement Filter (P-220F-E) (sold separately).
- After replacing the filters, dispose of the used supply air filters and exhaust air filters for in accordance with disposal methods designated in the region where you live.

Supply air filters and exhaust air filters are made of PET and acrylic fibers.

Note:

Use the filters below (sold separately) to suit your specific application.

Type	Model	Approximate Service Life	Notes
High Efficiency Supply Air Filter (contains 2 sheets)	P-220SHF-E	1 year (replacement) Cannot be cleaned	Can be replaced with supply air filter. (M6 class, EN779:2012)
Medium Efficiency Exhaust Air Filter (contains 2 sheets)	P-220EMF-E	2 years (replacement) Clean approximately once every 6 months	Can be replaced with exhaust air filter. (G4 class, EN779:2012)
Standard Replacement Filter (contains 2 sheets)	P-220F-E	Replace when broken Can be washed with water and re-used 4 times	Can be replaced with supply air filter and exhaust air filter. (G3 class, EN779:2012)

How to replace filters (sold separately)

Remove the supply air filters or exhaust air filters, and install new filters (sold separately).

Note:

- Be sure to install filters in the filter case before installing the filter case on the Lossnay unit.
- Do not mix up supply air filters and exhaust air filters.

How to clean drain pan (supply air side)

Clean the drain pan (supply air side) with a vacuum cleaner if you are worried about dirt or dust sticking to the pan.

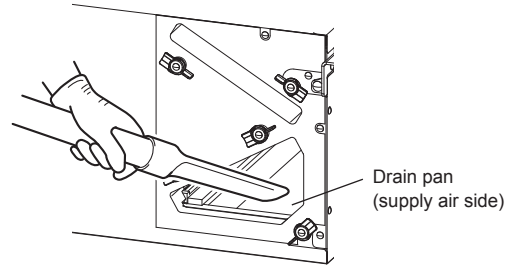

Note:

- Before cleaning the drain pan (supply air side), make sure that no dew condensation water on the drain pan.

Assembling and checking after cleaning and maintenance

⚠ CAUTION

Securely install parts after cleaning and maintenance.
Injury could result if parts fall.

1. Install the filter on the filter case by following the disassembly procedure in reverse.
 - Make sure that the filter is not protruded from the filter case.
2. Install the supply air filter case on the Lossnay unit.
3. Turn the three supply air filter fixing knobs to secure the knobs to the Lossnay unit.
4. Install the exhaust air filter case to the Lossnay unit.
5. Turn the two exhaust air filter fixing knobs to secure the knobs to the Lossnay unit.
6. When you have finished assembling the Lossnay unit, press the ON/OFF button on the remote controller to check the following:
 - Check for emission of abnormal noise.
 - Check for normal air flow.
 - Check for air leakage from the installation section of the supply air filter case or exhaust air filter case.
7. Reset the filter cleaning sign.
 - For details on how to reset the filter cleaning sign, see page 9 or page 12.

Note:

- In some operating environments, dew condensation water or snow/mist water droplets may adhere to the filters. This, however, is not a problem in product performance or quality.
- Do not forget to install the filters inside the Lossnay unit. (Doing so results in dirt clogging the surface of the Lossnay core or a drop in fan speed.)
- Use filters (sold separately) to suit your specific application if you are worried about small insects getting inside or small dirt or dust particles.

7. Troubleshooting

Take the following actions if trouble shown in the table below occurs. If trouble is not corrected even after taking the required action, or if trouble other than that indicated in the following table occurs, turn OFF the circuit breaker on the power board, and then contact your dealer or an electrical contractor.

Symptom	Cause	Action
No operation	Power is not supplied to the Lossnay unit.	Check the circuit breaker on the power board.
	The ON/OFF button on the remote controller is not "ON".	Press the ON/OFF button on the remote controller to turn on.
Operating noise has increased	The filter is not installed securely.	Re-install the filter. (see page 14.)
	The filter is clogged.	Clean the filter. (see pages 13 and 14.)
	The outdoor hood is blocked.	Remove obstacles.
Air flow has reduced	The filter is clogged.	Clean the filter. (see pages 13 and 14.)
Burbling noise from product	Dew condensation water in the drain pipes is sucked into the wind taken in by the ventilation unit but is not being discharged.	Change the ventilation unit mode to low operation. This makes it easier for dew condensation water in the drain pipes to be discharged and will eliminate the knocking noise.
Noise fluctuates	Noise sometimes gets louder because of the influence of outside wind. This is not a malfunction.	If you are worried about sound fluctuation, contact your dealer or an electrical contractor.
Dew condensation water in the filter case	Dew condensation water sometimes builds up in some operating environments.	It is not a malfunction.
The volume of the operating noise is different in different rooms	The volume of the noise sometimes differs, for example, because of the length of the piping to each room.	It is not a malfunction.
Sometimes air stops being blown out of the Lossnay unit	The unit is operating in the supply air intermittent mode.	It is not a malfunction. See "Automatic supply air stop function/Automatic supply air intermittent operation function." (see below)
Supply air flow is cold	The outdoor air temperature is low.	It is not a malfunction. Supply air sometimes is cooled by the outside air.

Automatic supply air stop function/Automatic supply air intermittent operation function

To prevent dew condensation forming on the Lossnay core and water droplets from adhering to the product when there is a drop in the temperature of the outside air, operation of the supply air fan is controlled to approximately the following temperatures.

Supply air stop mode (continuous supply air stopped)	Supply air intermittent operation (24-minute operation followed by a 6-minute stop)	Continuous operation
Outdoor air temperature -5°C or lower	-5°C or more from outdoor air temperature of 0°C	Outdoor air temperature 0°C or higher

Note:

- The exhaust fan runs continuously regardless of outdoor air temperature.
- Even while the supply air fan has stopped, the Lossnay unit sometimes operates periodically to measure the outdoor air temperature.

8. Specifications

Model		VL-220CZGV-E			
Electrical power supply		220-240 V / 50 Hz 220 V / 60 Hz			
Ventilation mode		Heat recovery mode			
Fan speed		Fan speed 4	Fan speed 3	Fan speed 2	Fan speed 1
Input power (W)		80	35	18.5	8.5
Air volume	(m ³ /h)	230	165	120	65
	(L/s)	64	46	33	18
External static pressure (Pa)		164	84	44	13
Temperature exchange efficiency (%)		82	84	85	86
Noise (dB)	(Measured at 1.5 m under the centre an anechoic chamber)	31	25	19	14
Weight (kg)		31			

* The running current, the input power, the efficiency and the noise are based on the rating air volume, and 230 V / 50 Hz.

* For the specification at the other frequency contact your dealer.

9. After-Sales Service

Consult with your dealer about the after-sales services provided for Lossnay.

- If you hear strange sounds, if no air is blown out or if some other trouble occurs, turn off the power and contact your dealer. Consult with your dealer concerning the cost of inspection or repair work.

■ Retention period of functional repair parts

We will retain the functional repair parts for six years after terminating production of the product.

The functional repair part means a part which is necessary to maintain the function of the product.

■ Recommended inspection and maintenance

After several years of use, the following might occur. We recommend inspection and maintenance by a professional.

- Water leakage due to clogging of drain hose
- Entry of dust due to deterioration of filters
- Abnormal noise or vibration due to the motor reaching the end of its service life
- Air leakage due to the heat exchanger Lossnay core reaching the end of its service life

The following are consumables:

- Motor
- Supply air filter
- Exhaust air filter
- Lossnay core

■ Repair costs include technical fee, cost of parts, (and business trip charges), etc.

Manufactured by: **MITSUBISHI ELECTRIC CORPORATION**

TOKYO BLDG. 2-7-3, MARUNOUCHI, CHIYODA-KU, TOKYO, 100-8310 JAPAN

Importer in EU: MITSUBISHI ELECTRIC EUROPE B.V.

HARMAN HOUSE, 1 GEORGE STREET, UXBRIDGE, MIDDLESEX, UB8 1QQ, U.K.

Information on Disposal



Note: This symbol mark is for EU countries only.

This symbol mark is according to the directive 2012/19/EU Article 14 Information for users and Annex IX, and/or to the directive 2006/66/EC Article 20 Information for end-users and Annex II.

English

Your MITSUBISHI ELECTRIC product is designed and manufactured with high quality materials and components which can be recycled and/or reused.

This symbol means that electrical and electronic equipment, batteries and accumulators, at their end-of-life, should be disposed of separately from your household waste.

If a chemical symbol is printed beneath the symbol shown above, this chemical symbol means that the battery or accumulator contains a heavy metal at a certain concentration. This will be indicated as follows:

Hg: mercury (0,0005%), Cd: cadmium (0,002%),

Pb: lead (0,004%)

In the European Union there are separate collection systems for used electrical and electronic products, batteries and accumulators.

Please, dispose of this equipment, batteries and accumulators correctly at your local community waste collection/recycling centre.

Please, help us to conserve the environment we live in!

Deutsch

Ihr MITSUBISHI ELECTRIC-Produkt wurde unter Einsatz von qualitativ hochwertigen Materialien und Komponenten konstruiert und gefertigt, die für Recycling und/oder Wiederverwendung geeignet sind.

Dieses Symbol bedeutet, dass elektrische und elektronische Geräte sowie Batterien und Akkus am Ende ihrer Nutzungsdauer von Hausmüll getrennt zu entsorgen sind.

Wenn ein chemisches Symbol unterhalb des oben abgebildeten Symbols erscheint, bedeutet dies, dass die Batterie bzw. der Akku ein Schwermetall in einer bestimmten Konzentration enthält. Dies wird wie folgt angegeben:

Hg: Quecksilber (0,0005 %), Cd: Cadmium (0,002 %),

Pb: Blei (0,004 %)

In der Europäischen Union gibt es unterschiedliche Sammelsysteme für gebrauchte Elektrik- und Elektronikgeräte einerseits sowie Batterien und Akkus andererseits.

Bitte entsorgen Sie dieses Gerät, Batterien und Akkus vorschriftsmäßig bei Ihrer kommunalen Sammelstelle oder im örtlichen Recycling-Zentrum.

Bitte helfen Sie uns, die Umwelt zu erhalten, in der wir leben!

Italiano

Questo prodotto MITSUBISHI ELECTRIC è stato progettato e fabbricato con materiali e componenti di alta qualità, che possono essere riciclati e/o riutilizzati.

Questo simbolo significa che i prodotti elettrici ed elettronici, le batterie e gli accumulatori, devono essere smaltiti separatamente dai rifiuti casalinghi alla fine della loro vita di servizio.

Se sotto il simbolo mostrato sopra è stampato un simbolo chimico, il simbolo chimico significa che la batteria o l'accumulatore contiene un metallo pesante con una certa concentrazione. Ciò viene indicato come segue:

Hg: mercurio (0,0005%), Cd: cadmio (0,002%),

Pb: piombo (0,004%)

Nell'Unione Europea ci sono sistemi di raccolta differenziata per i prodotti elettrici ed elettronici, le batterie e gli accumulatori usati.

Per disfarsi di questo prodotto, delle batterie e degli accumulatori, portarli al centro locale di raccolta/riciclaggio dei rifiuti.

Aiutateci a conservare l'ambiente in cui viviamo!

Français

Votre produit Mitsubishi Electric est conçu et fabriqué avec des matériels et des composants de qualité supérieure qui peuvent être recyclés et/ou réutilisés.

Ce symbole signifie que les équipements électriques et électroniques, les batteries et les accumulateurs, à la fin de leur durée de service, doivent être éliminés séparément des ordures ménagères.

Si un symbole chimique est imprimé sous le symbole illustré ci-dessus, il signifie que la batterie ou l'accumulateur contient une certaine concentration de métal lourd. Elle sera indiquée comme suit :

Hg : mercure (0,0005%), Cd : cadmium (0,002%),

Pb : plomb (0,004%)

Dans l'Union Européenne, il existe des systèmes sélectifs de collecte pour les produits électriques et électroniques, les batteries et les accumulateurs usagés.

Nous vous prions donc de confier cet équipement, ces batteries et ces accumulateurs à votre centre local de collecte/recyclage.

Aidez-nous à conserver l'environnement dans lequel nous vivons !

Les machines ou appareils électriques et électroniques contiennent souvent des matières qui, si elles sont traitées ou éliminées de manière inappropriée, peuvent s'avérer potentiellement dangereuses pour la santé humaine et pour l'environnement.

Cependant, ces matières sont nécessaires au bon fonctionnement de votre appareil ou de votre machine.

Pour cette raison, il vous est demandé de ne pas vous débarrasser de votre appareil ou machine usagé avec vos ordures ménagères.

Español

Su producto MITSUBISHI ELECTRIC está diseñado y fabricado con materiales y componentes de alta calidad que pueden ser reciclados y/o reutilizados.

Este símbolo significa que el aparato eléctrico y electrónico, las pilas, baterías y los acumuladores, al final de su ciclo de vida, se deben tirar separadamente del resto de sus residuos domésticos.

Si hay un símbolo químico impreso debajo del símbolo mostrado arriba, este símbolo químico significa que la pila, batería o el acumulador contienen un metal pesado con cierta concentración. Esto se indicará de la forma siguiente:

Hg: mercurio (0,0005%), Cd: cadmio (0,002%),

Pb: plomo (0,004%)

En la Unión Europea existen sistemas de recogida específicos para productos eléctricos y electrónicos, pilas, baterías y acumuladores usados.

Por favor, deposite los aparatos mencionados, las pilas, baterías y acumuladores en el centro de recogida/reciclado de residuos de su lugar de residencia local cuando quiera tirarlos.

¡Ayúdenos a conservar el medio ambiente!

Português

O seu produto MITSUBISHI ELECTRIC foi concebido e produzido com materiais e componentes de alta qualidade que podem ser reciclados e/ou reutilizados.

Este símbolo significa que o equipamento eléctrico e electrónico, as baterias e os acumuladores, no final da sua vida útil, devem ser deitados fora separadamente do lixo doméstico.

Se houver um símbolo químico impresso por baixo do símbolo mostrado acima, o símbolo químico indica que a bateria ou acumulador contém metais pesados numa determinada concentração. Isto aparecerá indicado da maneira seguinte:

Hg: mercúrio (0,0005%), Cd: cádmio (0,002%),

Pb: chumbo (0,004%)

Na União Europeia existem sistemas de recolha separados para produtos eléctricos e electrónicos, baterias e acumuladores usados.

Por favor, entregue este equipamento, as baterias e os acumuladores correctamente, no seu ponto local de recolha/reciclagem.

Por favor, ajude-nos a conservar o ambiente em que vivemos!



Svenska

Denna produkt från MITSUBISHI ELECTRIC är designad och tillverkad av material och komponenter med hög kvalitet som kan återvinnas och/eller återanvändas.

Denna symbol betyder att förbrukade elektriska och elektroniska produkter, batterier och ackumulatörer skall sorteras och hanteras separat från hushållsavfall.

Om det finns en kemisk beteckning tryckt under ovanstående symbol betyder det att batteriet eller ackumulatören innehåller en tungmetall med en viss koncentration. Detta anges på följande sätt:

Hg: kvicksilver (0,0005%), Cd: kadmium (0,002%),
Pb: bly (0,004%)

Inom den Europeiska Unionen finns det separata insamlingsystem för begagnade elektriska och elektroniska produkter, batterier och ackumulatörer.

Var vänlig lämna denna produkt, batterier och ackumulatörer hos din lokala mottagningsstation för avfall och återvinning.

Var snäll och hjälp oss att bevara miljön vi lever i!

Dansk

Dit produkt fra MITSUBISHI ELECTRIC er designet og fremstillet med kvalitetsmaterialer og komponenter, der kan genindvindes og/eller genbruges.

Dette symbol viser, at elektrisk eller elektronisk udstyr, batterier og akkumulatører ikke må bortskaffes sammen med almindeligt husholdningsaffald efter endt levetid.

Hvis der er trykt et kemisk symbol under symbolet ovenfor, betyder det, at batteriet eller akkumulatøren indeholder en bestemt koncentration af et tungmetall. Dette angives som følger:

Hg: kviksølv (0,0005 %), Cd: cadmium (0,002 %),
Pb: bly (0,004 %)

I EU er der særlige indsamlingsordninger for brugte elektriske og elektroniske produkter, batterier og akkumulatører.

Bortskaf udstyret, batterier og akkumulatører korrekt på en lokal affalds-/genbrugsplads.

Hjælp os med at bevare det miljø, vi lever i!

Norsk

For norske brukere:

Dette produktet fra MITSUBISHI ELECTRIC er konstruert og produsert med materialer og komponenter av høy kvalitet, som kan resirkuleres og/eller brukes om igjen.

Dette symbolet betyr at elektrisk og elektronisk utstyr, batterier og akkumulatører, ikke bør kasseres sammen med husholdningsavfallet når de har nådd slutten av sin levetid.

Hvis det er trykt et kjemisk symbol under det symbolet som er vist over, betyr det kjemiske symbolet at batteriet eller akkumulatøren inneholder et tungmetall i en viss konsentrasjon. Dette vil vises som følger:

Hg: kvikksølv (0,0005 %), Cd: kadmium (0,002 %),
Pb: bly (0,004 %)

I Norge finnes det egne innsamlingsystemer for brukte elektriske og elektroniske produkter, batterier og akkumulatører. Kasser dette utstyret, batteriene og akkumulatørene ved den lokale gjenbruks- eller resirkuleringsstasjonen.

Hjelp oss å bevare det miljøet vi lever i!

Suomi

Tämä MITSUBISHI ELECTRIC -tuote on suunniteltu ja valmistettu korkealuokkaisista materiaaleista ja/tai osista, jotka voidaan kierrättää ja käyttää uudelleen.

Tämä symboli tarkoittaa, että sähkö- ja elektroniikkalaitteet, paristot ja akut täytyy niiden käyttöänsä jälkeen hävittää erillään talousjätteistä.

Jos yllä olevan symbolin alapuolelle on painettu kemiallinen symboli, se tarkoittaa, että paristolla tai akulla on tietty raskasmetallipitoisuus. Se ilmoitetaan seuraavasti:

Hg: elohopea (0,0005 %), Cd: kadmium (0,002 %),
Pb: lyijy (0,004 %)

Käytetyillä sähkö- ja elektroniikkalaitteilla, paristoilla ja akuilla on Euroopan Yhteisössä omat keräysjärjestelmänsä.

Toimita tämä laite, paristot ja akut paikalliseen jätehuolto-/kierrätyskeskukseen.

Auta meitä suojelemaan ympäristöä, jossa elämme!

Nederlands

Mitsubishi Electric producten zijn ontwikkeld en gefabriceerd uit eerste kwaliteit materialen. De onderdelen kunnen worden gerecycled en/of worden hergebruikt.

Het symbool betekent dat de elektrische en elektronische onderdelen, batterijen en accu's op het einde van de gebruiksduur gescheiden van het huishoudelijk afval moeten worden ingezameld. Wanneer er onder het bovenstaande symbool een chemisch symbool staat gedrukt, betekent dit dat de batterij of accu zware metalen in een bepaalde concentratie bevat. Dit wordt als volgt aangeduid:

Hg: kwik (0,0005%), Cd: cadmium (0,002%),
Pb: lood (0,004%)

In de Europese Unie worden elektrische en elektronische producten, batterijen en accu's afzonderlijk ingezameld.

Breng deze apparatuur, batterijen en accu's dan naar het gemeentelijke afvalinzamelingspunt.

Help ons mee het milieu te beschermen!

Ελληνικά

Το προϊόν MITSUBISHI ELECTRIC που διαθέτετε είναι σχεδιασμένο και κατασκευασμένο από υλικά και εξαρτήματα υψηλής ποιότητας, τα οποία μπορούν να ανακυκλωθούν ή/και να χρησιμοποιηθούν ξανά.

Το σύμβολο αυτό σημαίνει ότι ο ηλεκτρικός και ηλεκτρονικός εξοπλισμός, οι μπαταρίες και οι συσσωρευτές, στο τέλος της διάρκειας ζωής τους, θα πρέπει να απορριφτούν ξεχωριστά από τα υπόλοιπα οικιακά απορρίμμάτα σας.

Αν έχει εκτυπωθεί ένα χημικό σύμβολο κάτω από το σύμβολο που απεικονίζεται ανωτέρω, αυτό το χημικό σύμβολο σημαίνει ότι η μπαταρία ή ο συσσωρευτής περιέχει ένα βαρύ μέταλλο σε ορισμένη συγκέντρωση. Αυτό θα υποδεικνύεται ως ακολούθως:

Hg: υδράργυρος (0,0005%), Cd: κάδμιο (0,002%),
Pb: μόλυβδος (0,004%)

Στην Ευρωπαϊκή Ένωση υπάρχουν ξεχωριστά συστήματα συλλογής για τα χρησιμοποιημένα ηλεκτρικά και ηλεκτρονικά προϊόντα, τις μπαταρίες και τους συσσωρευτές.

Παρακαλούμε διαθέστε αυτόν τον εξοπλισμό, τις μπαταρίες και τους συσσωρευτές στο τοπικό σας κοινοτικό κέντρο συλλογής/ανακύκλωσης απορριμμάτων.

Βοηθήστε μας να προστατεύσουμε το περιβάλλον στο οποίο ζούμε!